

CT MOLDINGS

SOLID

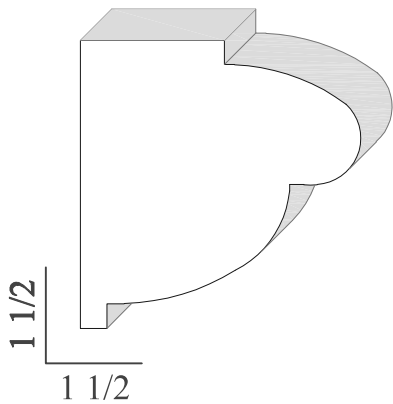

CTM | BM | 10000

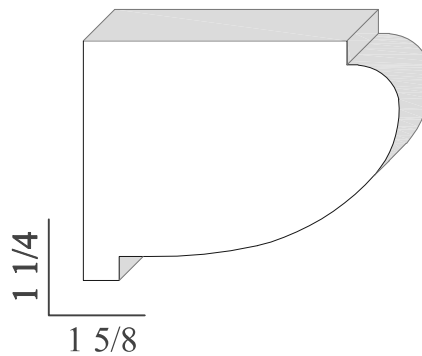

CTM | BM | 10001

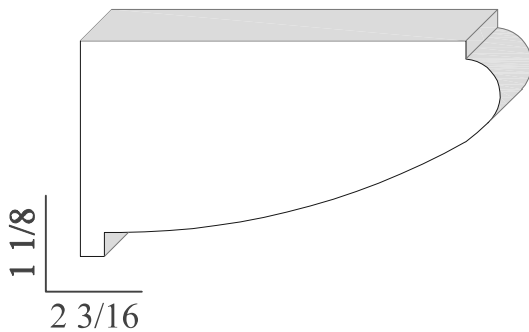

CTM | BM | 10002

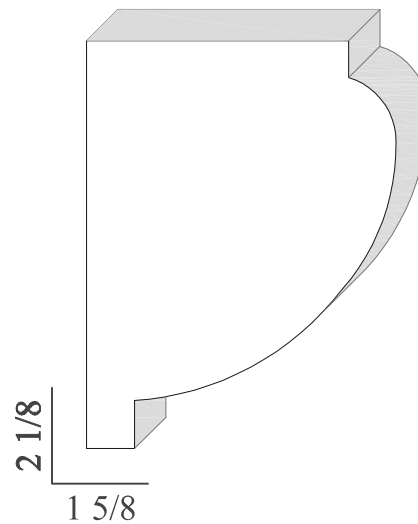

CTM | BM | 10003



CT MOLDINGS
SOLID

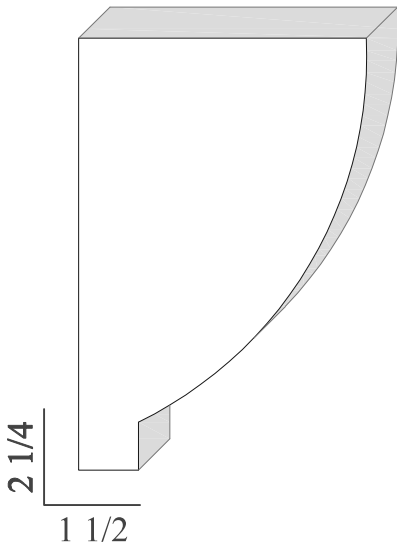

CTM | BM | 10004

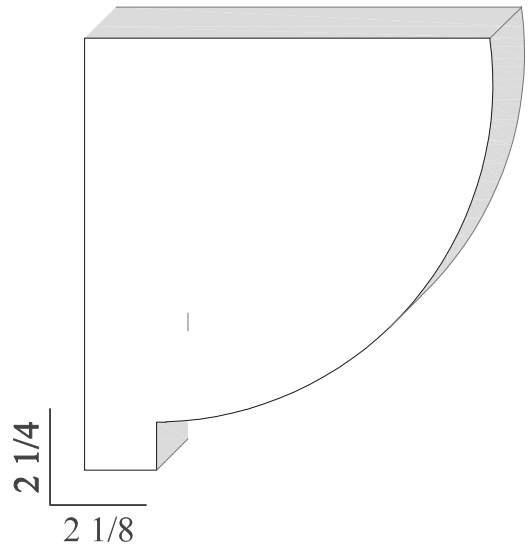

CTM | BM | 10005

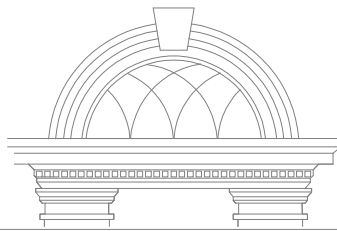

CT MOLDINGS

SOLID

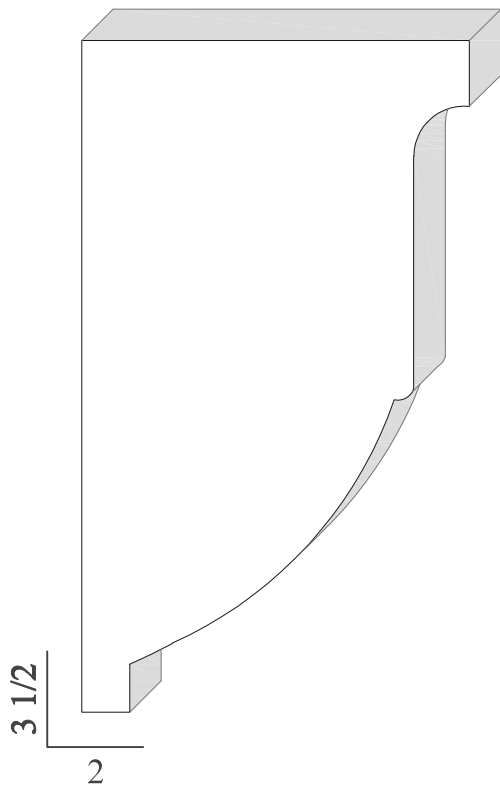

CTM | BM | 10006

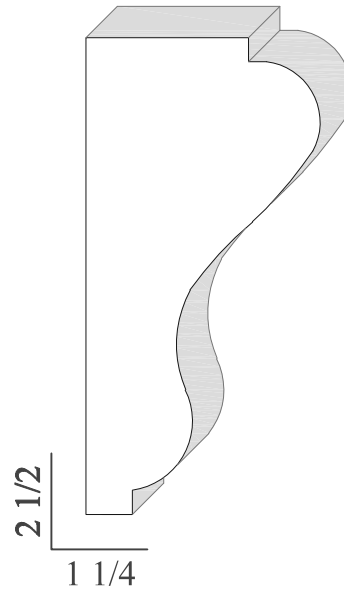

CTM | BM | 10007

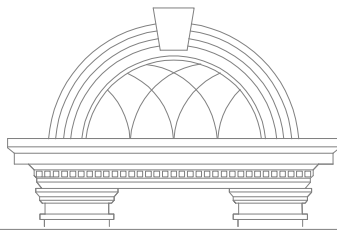

CT MOLDINGS

SOLID

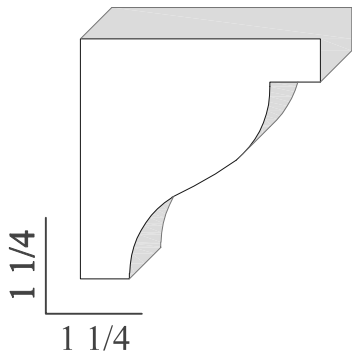

CTM | BM | 10009

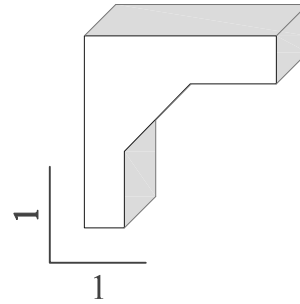

CTM | BM | 10010

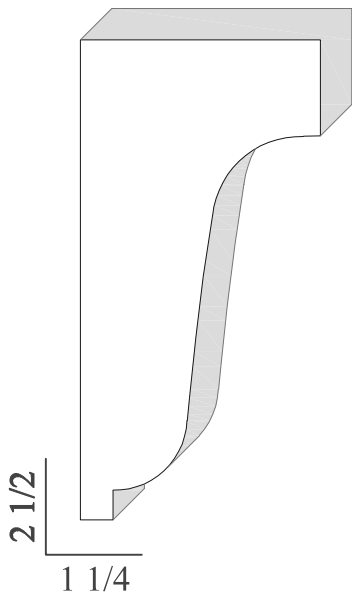

CTM | BM | 10011

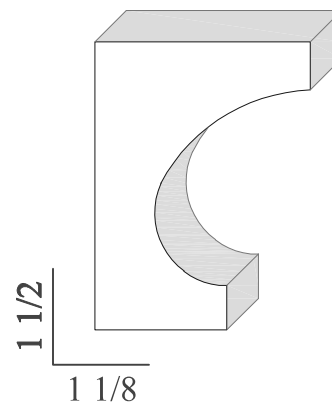

CTM | BM | 10012

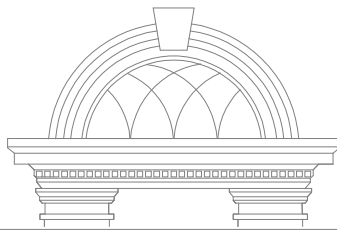

CT MOLDINGS

SOLID

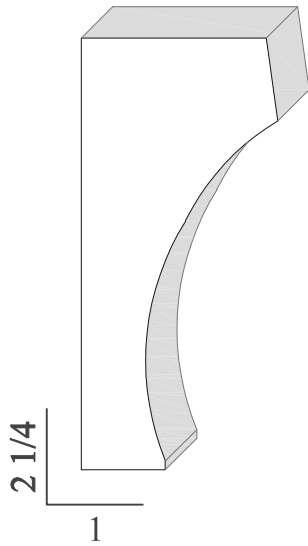

CTM | BM | 10013

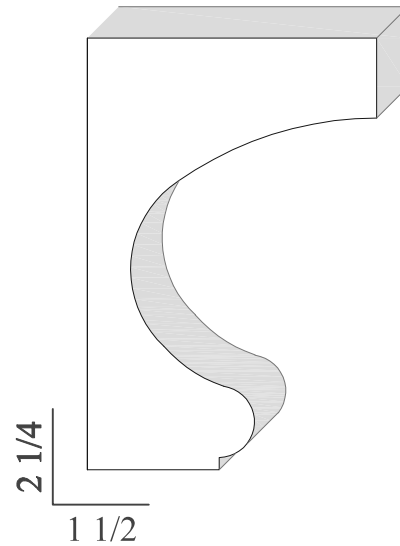

CTM | BM | 10014

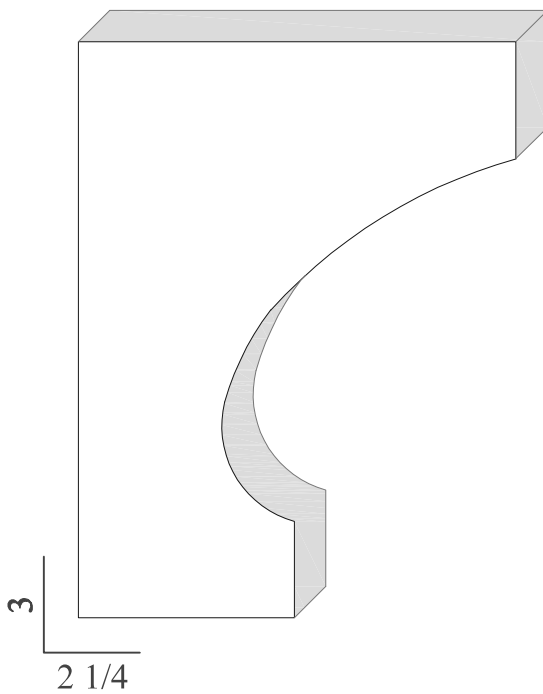

CTM | BM | 10015

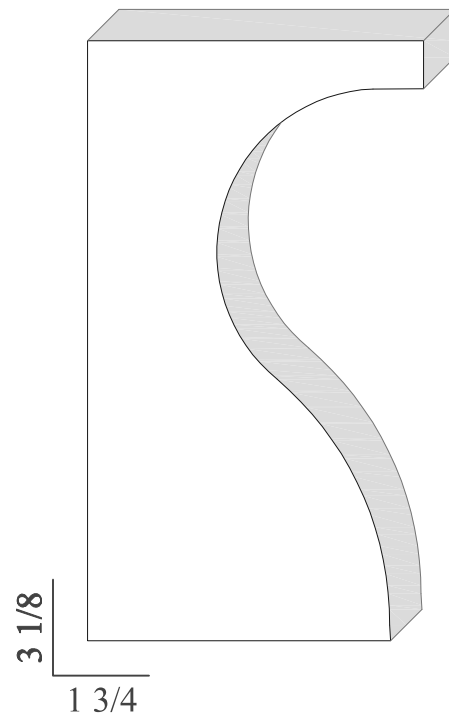

CTM | BM | 10016

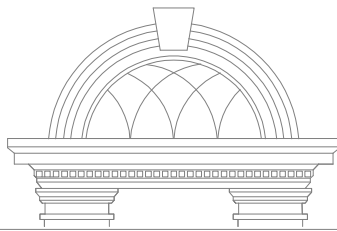

CT MOLDINGS

SOLID

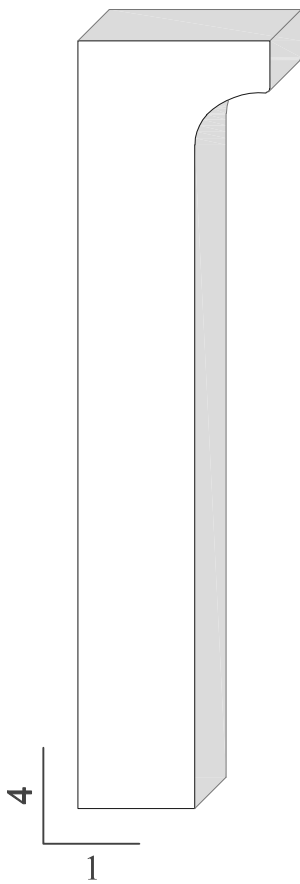

CTM | BM | 10017

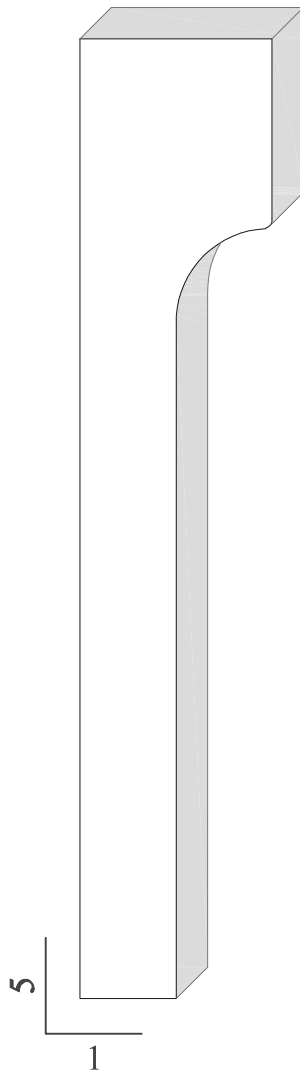

CTM | BM | 10018

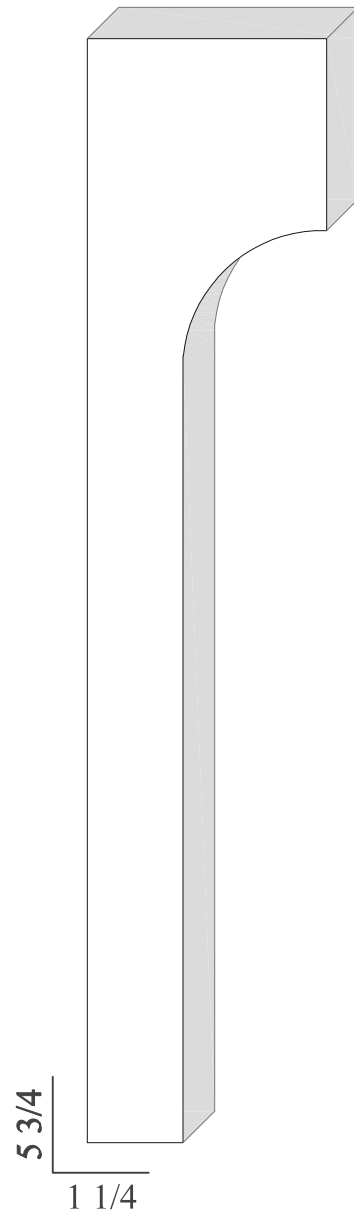

CTM | BM | 10019

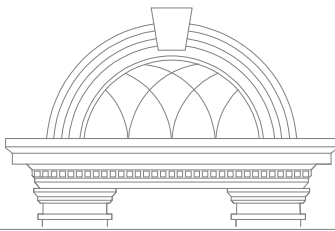

CT MOLDINGS

SOLID

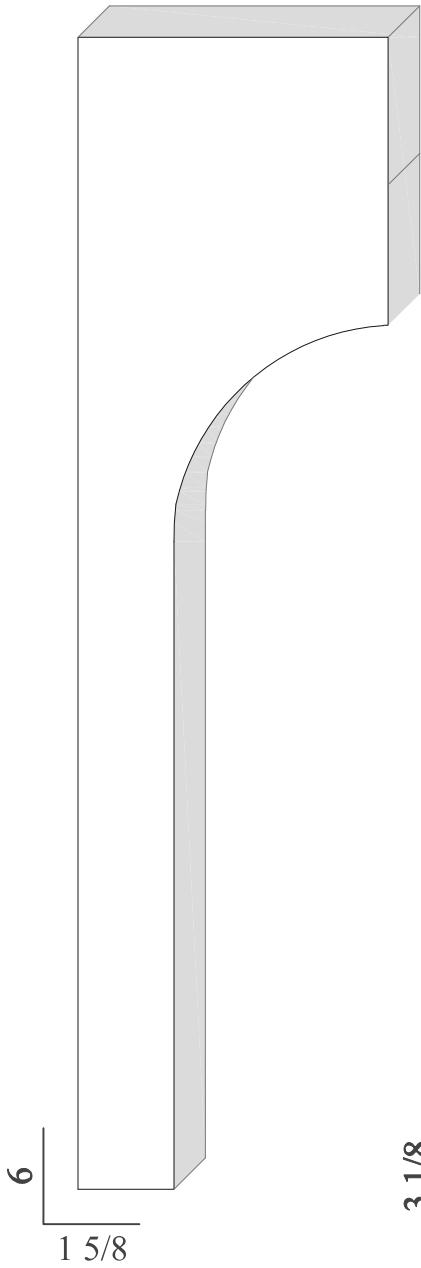

CTM | BM | 10020

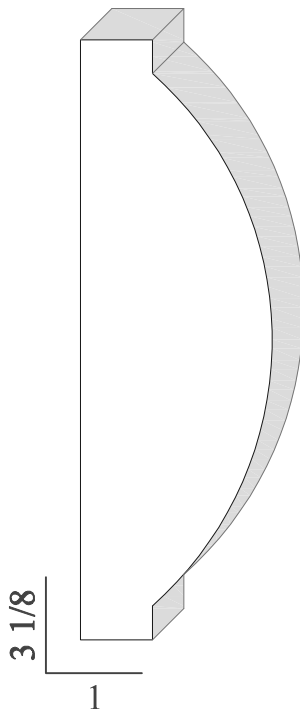

CTM | BM | 10022

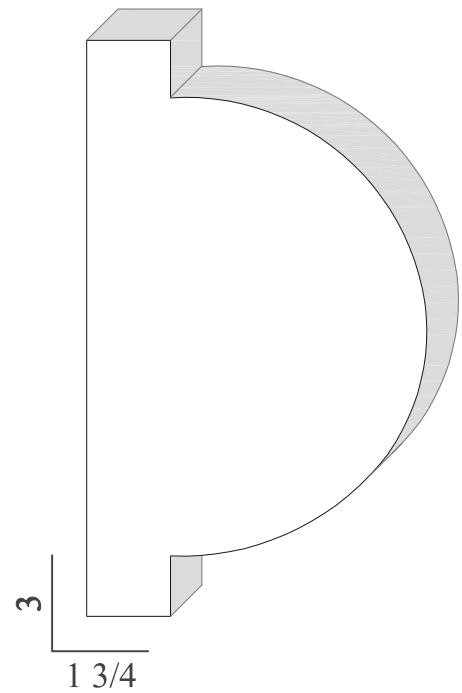

CTM | BM | 10021

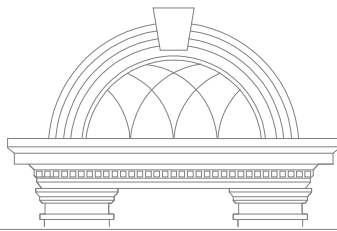

CT MOLDINGS

SOLID

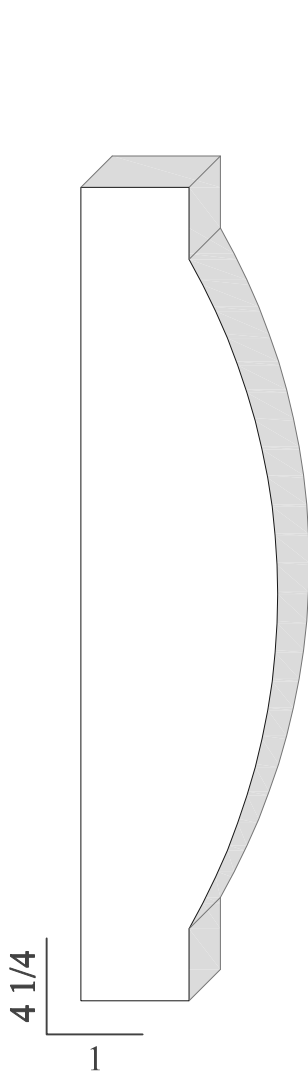

CTM | BM | 10023

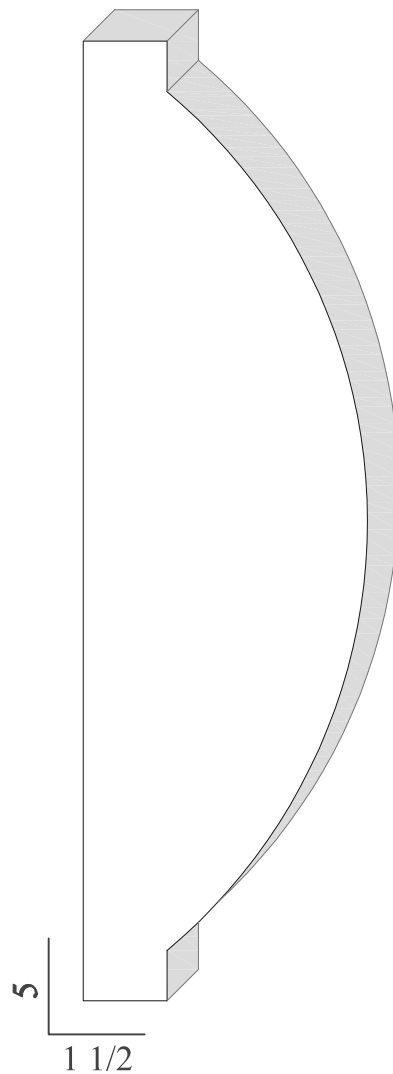

CTM | BM | 10024

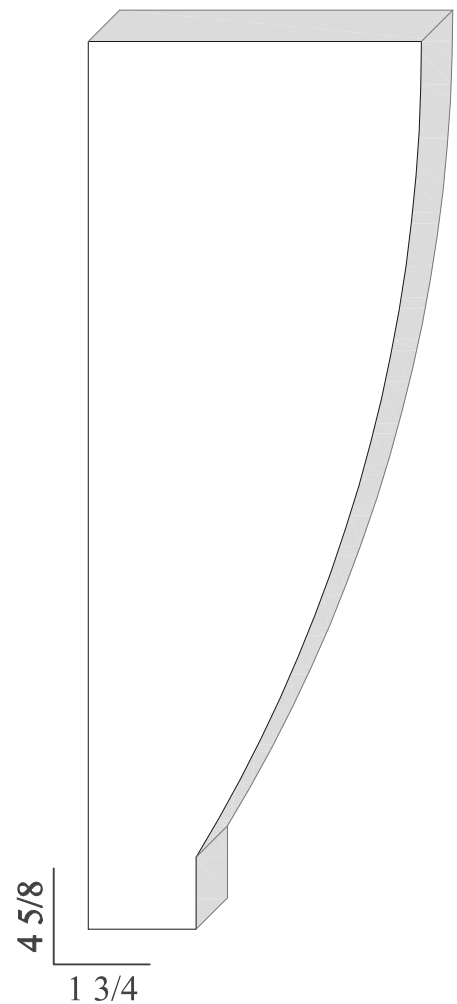

CTM | BM | 10025

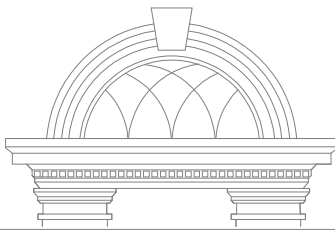

CT MOLDINGS

SOLID

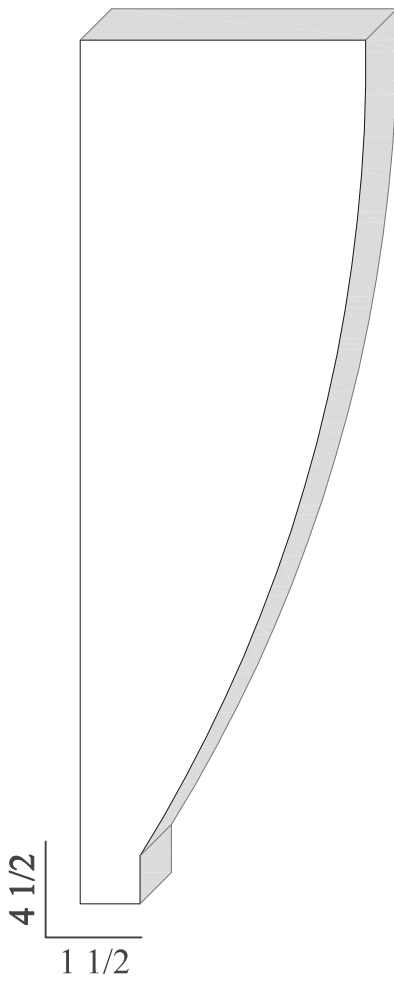

CTM | BM | 10026

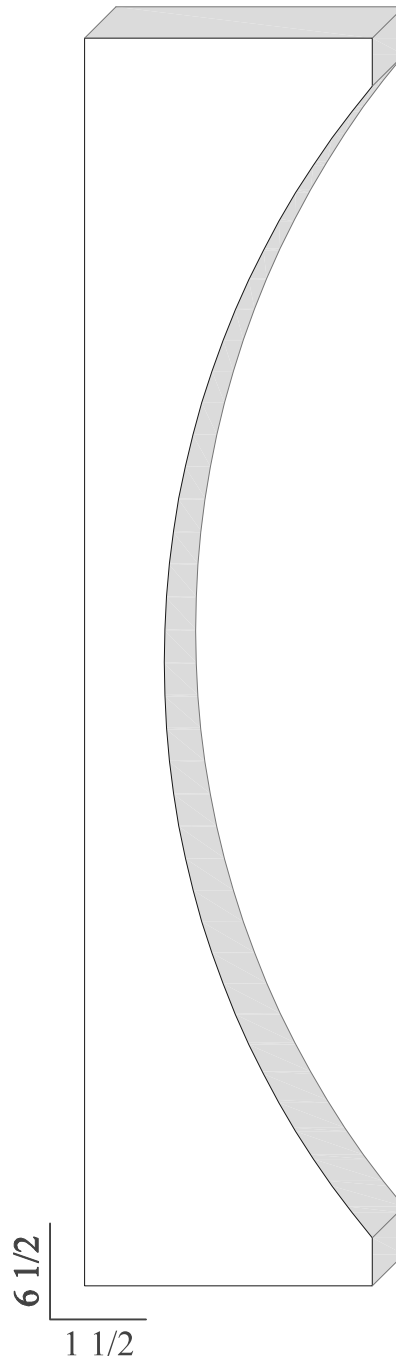

CTM | BM | 10027

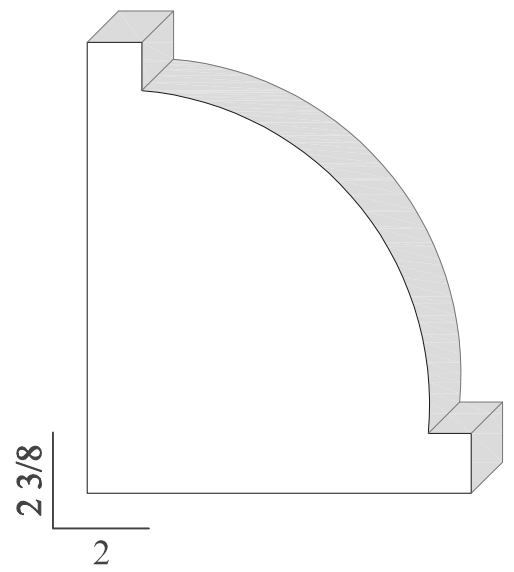

CTM | BM | 10028