

CT MOLDINGS

PANEL

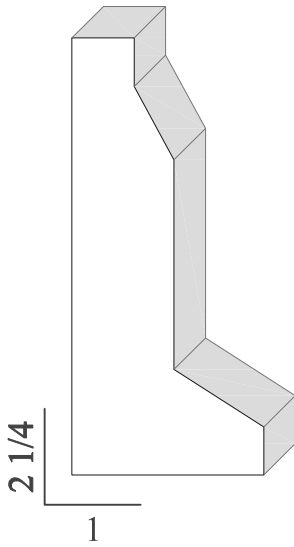

CTM | PA | 1000

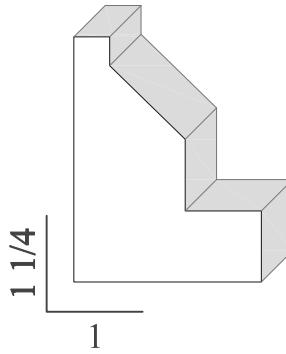

CTM | PA | 1002

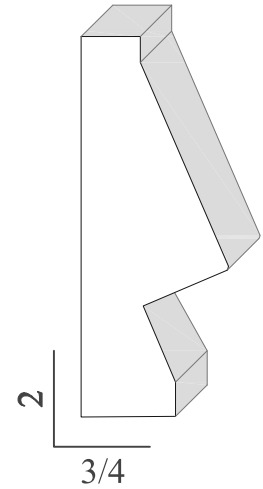

CTM | PA | 1003

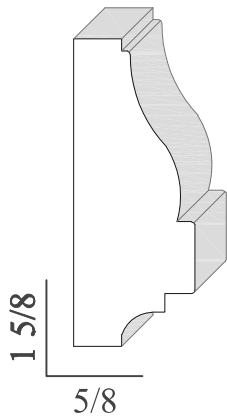

CTM | PA | 1003

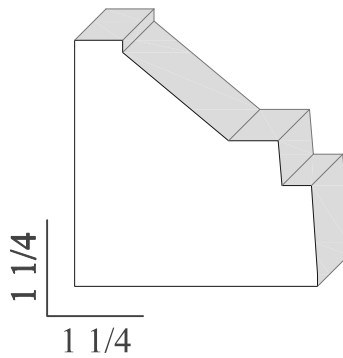

CTM | PA | 1004

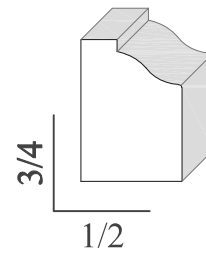

CTM | PA | 1005

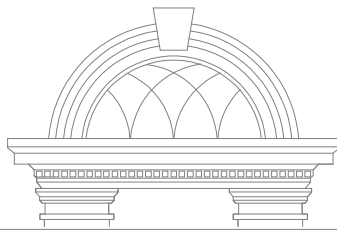

CT MOLDINGS

PANEL

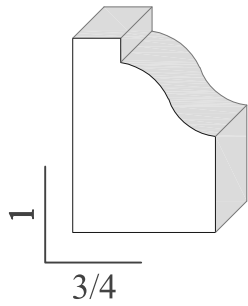

CTM | PA | 1006

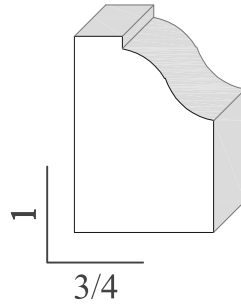

CTM | PA | 1007

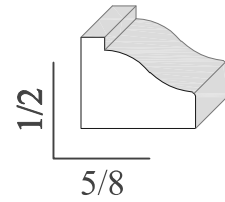

CTM | PA | 1008

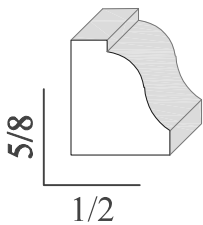

CTM | PA | 1009

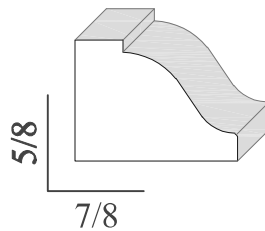

CTM | PA | 1010

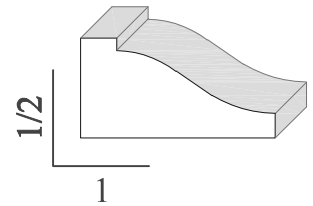

CTM | PA | 1011

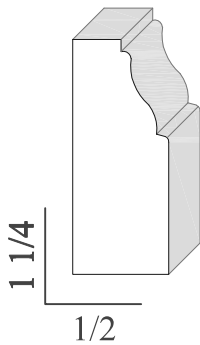

CTM | PA | 1012

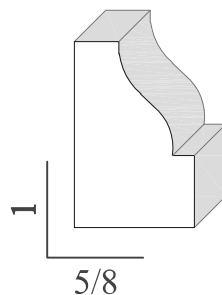

CTM | PA | 1013

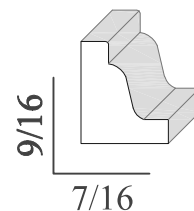

CTM | PA | 1014



CT MOLDINGS
PANEL

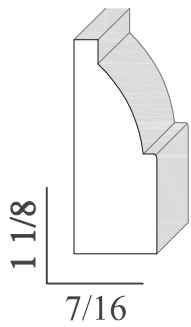

CTM | PA | 1015

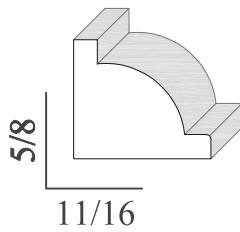

CTM | PA | 1016

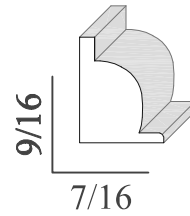

CTM | PA | 1016.1

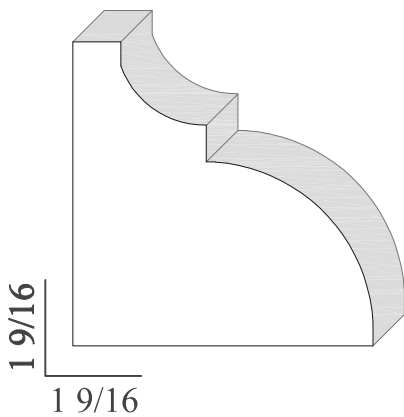

CTM | PA | 1017

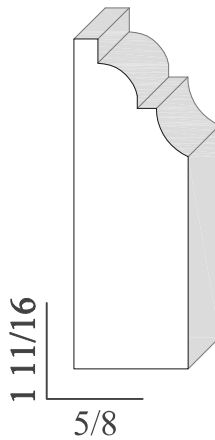

CTM | PA | 1018

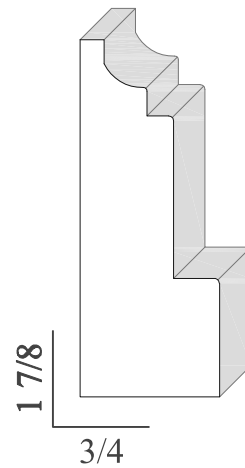

CTM | PA | 1019

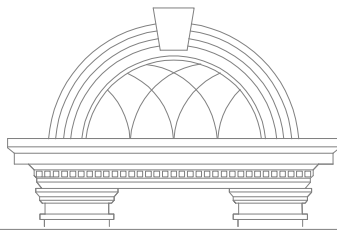

CT MOLDINGS

PANEL

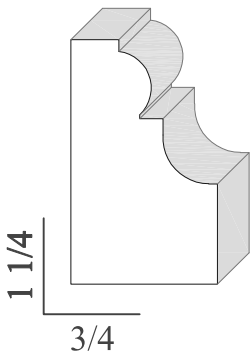

CTM | PA | 1020

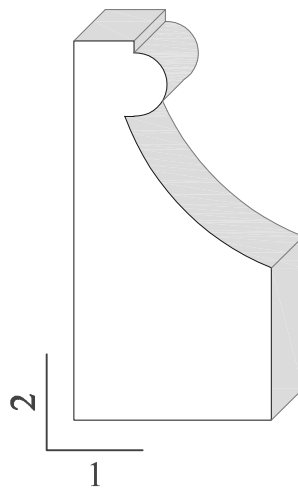

CTM | PA | 1021

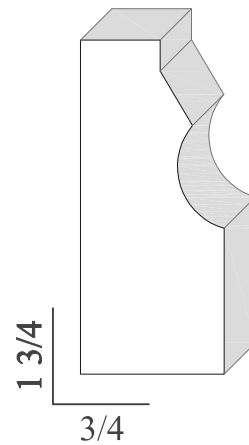

CTM | PA | 1022

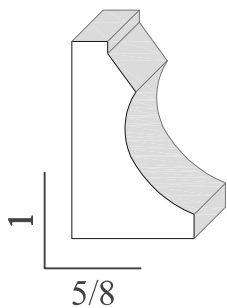

CTM | PA | 1023

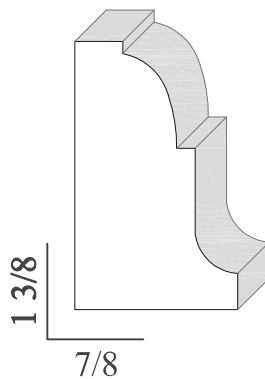

CTM | PA | 1024

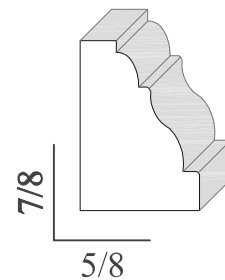

CTM | PA | 1025

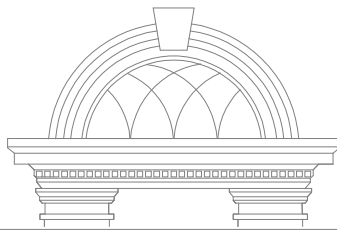

CT MOLDINGS

PANEL

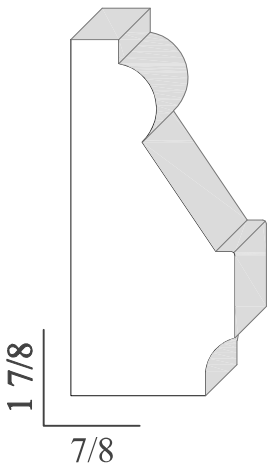

CTM | PA | 1026

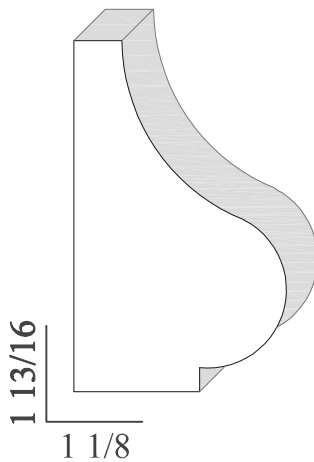

CTM | PA | 1027

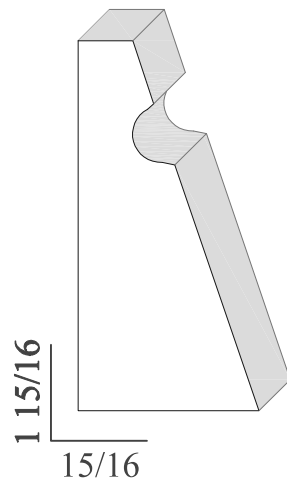

CTM | PA | 1028

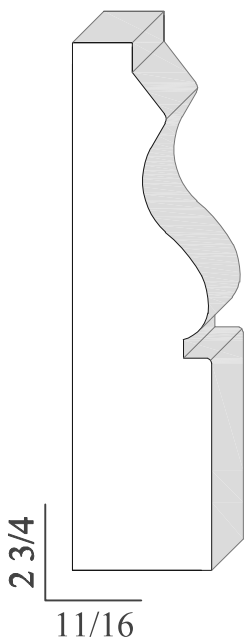

CTM | PA | 1029

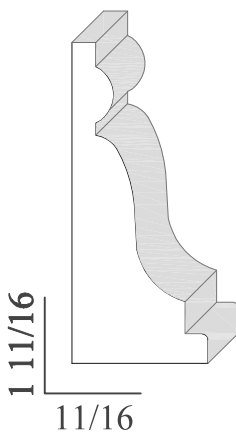

CTM | PA | 1030

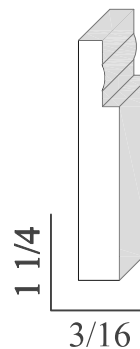

CTM | PA | 1031

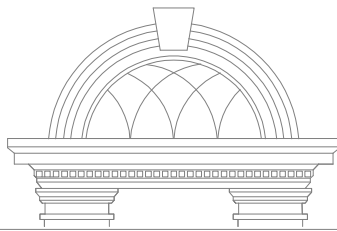

CT MOLDINGS

PANEL

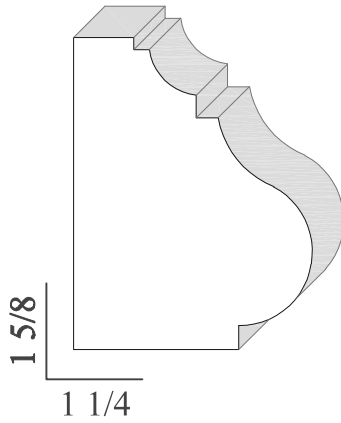

CTM | PA | 1032

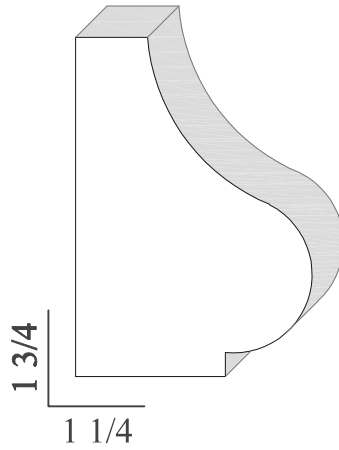

CTM | PA | 1033

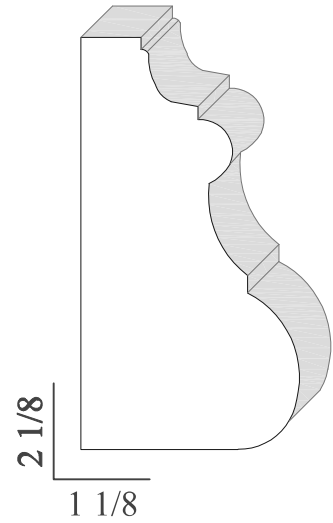

CTM | PA | 1034

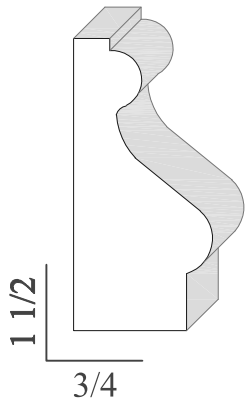

CTM | PA | 1035

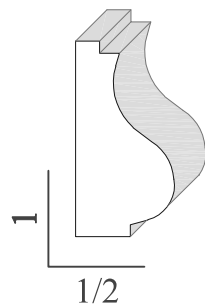

CTM | PA | 1036

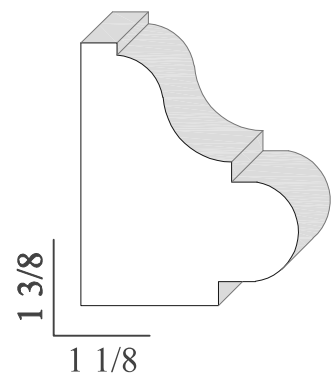

CTM | PA | 1037

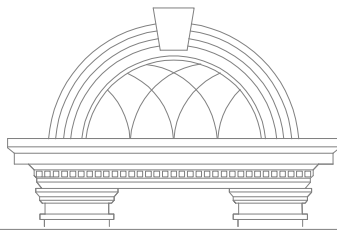

CT MOLDINGS

PANEL

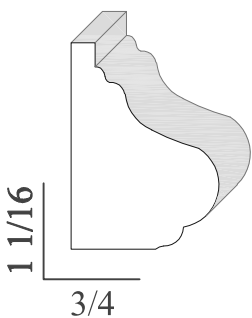

CTM | PA | 1038

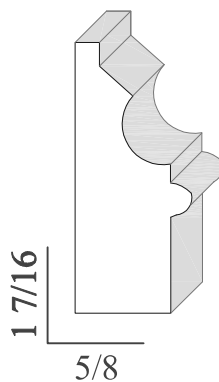

CTM | PA | 1039

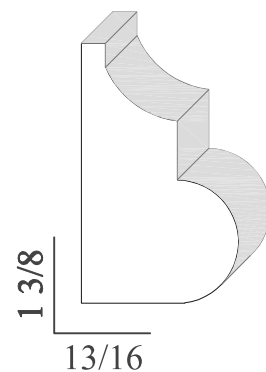

CTM | PA | 1041

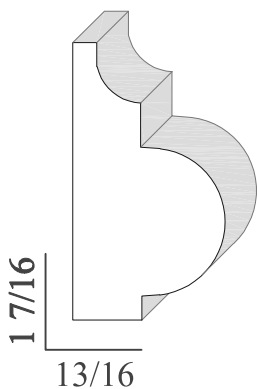

CTM | PA | 1041

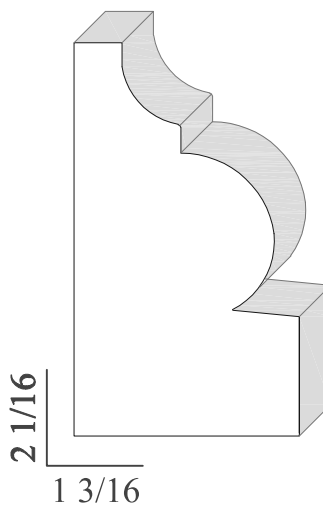

CTM | PA | 1042

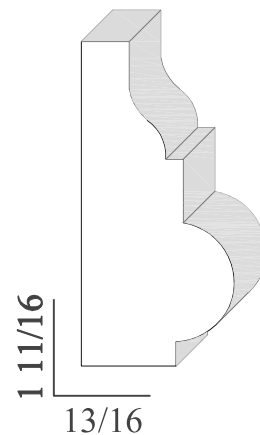

CTM | PA | 1043

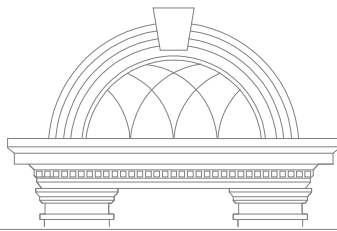

CT MOLDINGS

PANEL

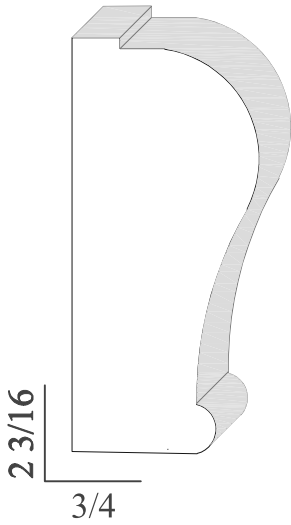

CTM | PA | 1044

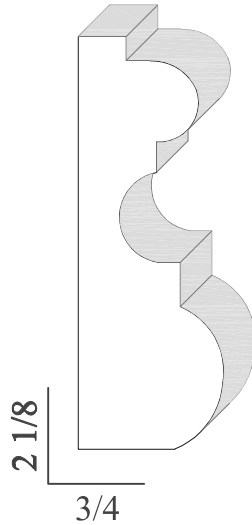

CTM | PA | 1045

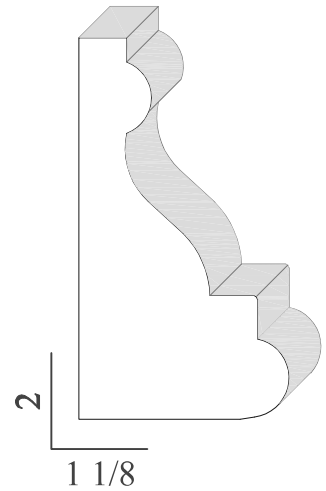

CTM | PA | 1046

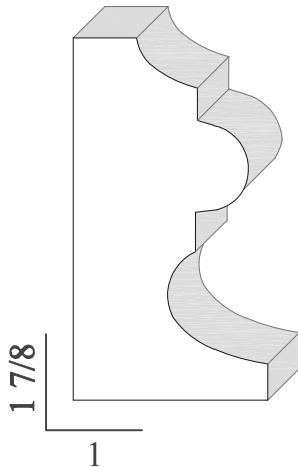

CTM | PA | 1047

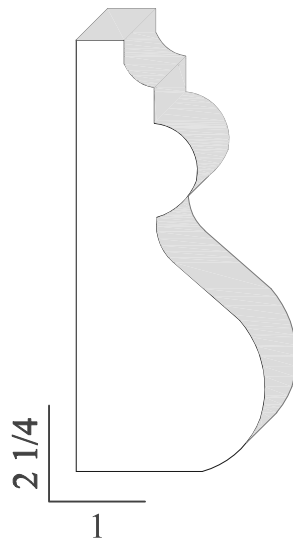

CTM | PA | 1048

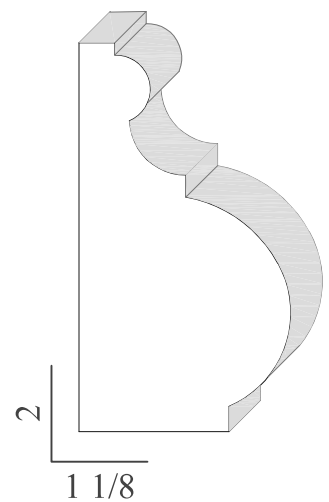

CTM | PA | 1049

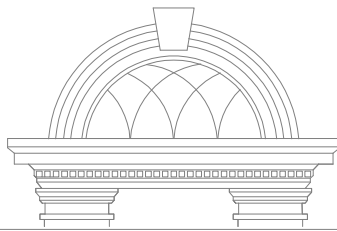

CT MOLDINGS

PANEL

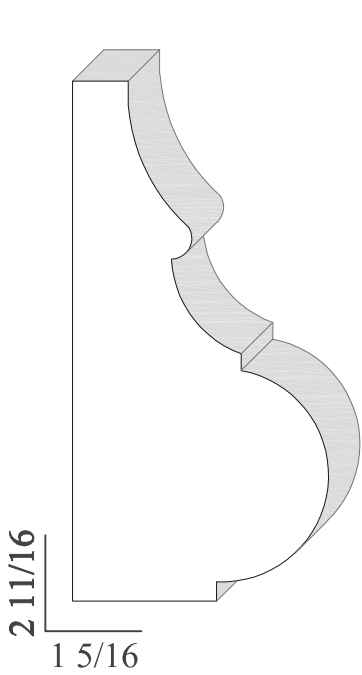

CTM | PA | 1050

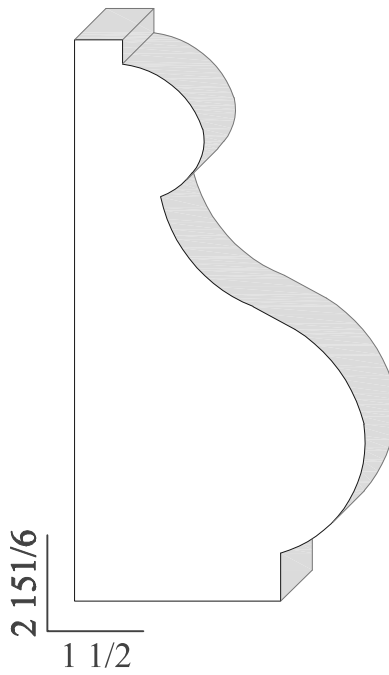

CTM | PA | 1051

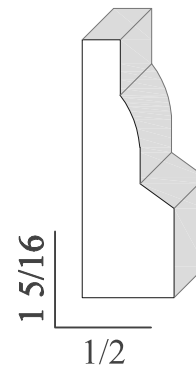

CTM | PA | 1052

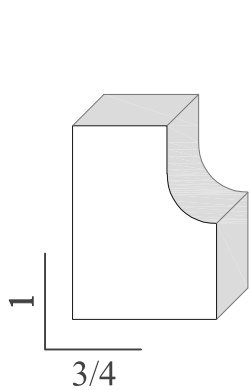

CTM | PA | 1053

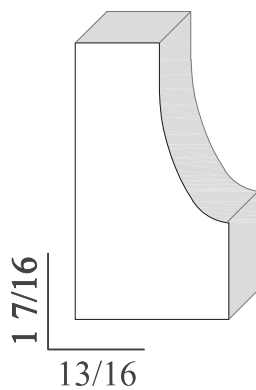

CTM | PA | 1054

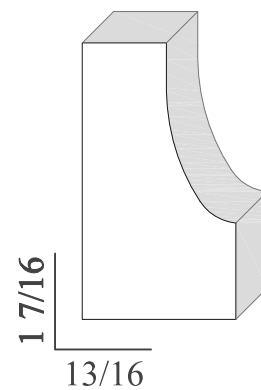

CTM | PA | 1055

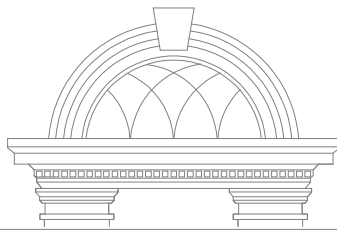

CT MOLDINGS

PANEL

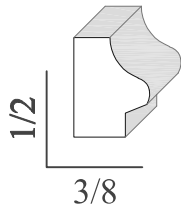

CTM | PA | 1056

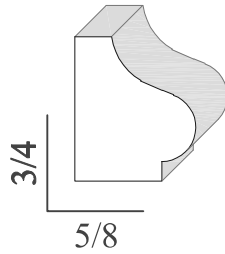

CTM | PA | 1057

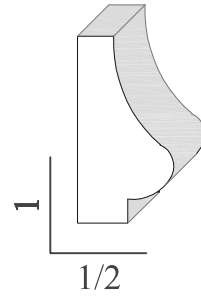

CTM | PA | 1058

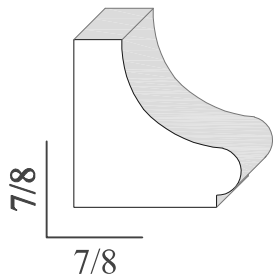

CTM | PA | 1059

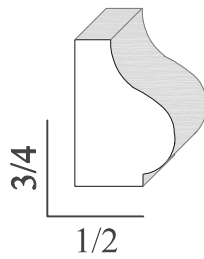

CTM | PA | 1060

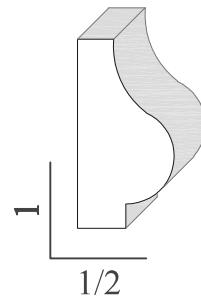

CTM | PA | 1061

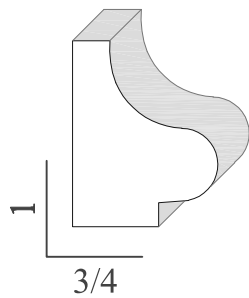

CTM | PA | 1062

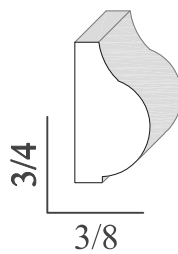

CTM | PA | 1063

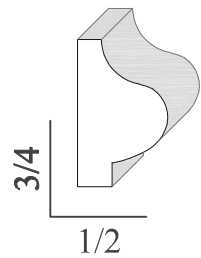

CTM | PA | 1064

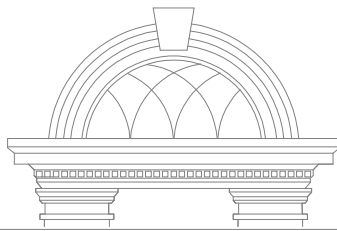

CT MOLDINGS

PANEL

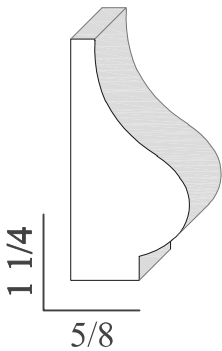

CTM | PA | 1065

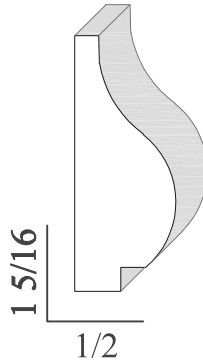

CTM | PA | 1066

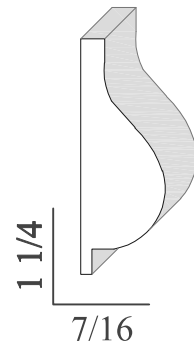

CTM | PA | 1067

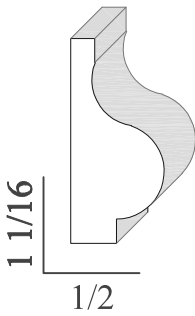

CTM | PA | 1068

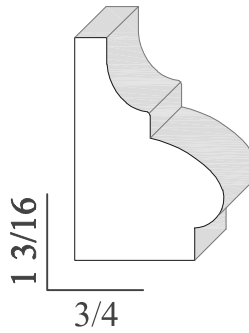

CTM | PA | 1068.1

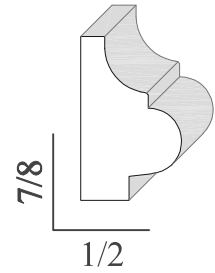

CTM | PA | 1069

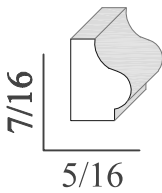

CTM | PA | 1070

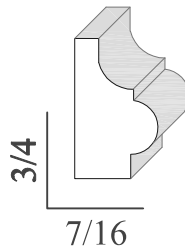

CTM | PA | 1071

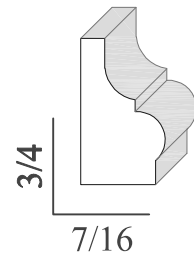

CTM | PA | 1072

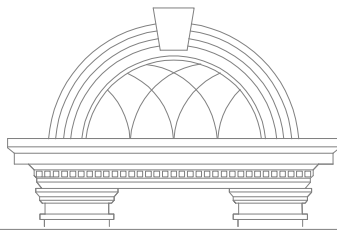

CT MOLDINGS

PANEL

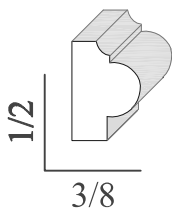

CTM | PA | 1073

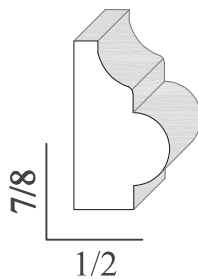

CTM | PA | 1074

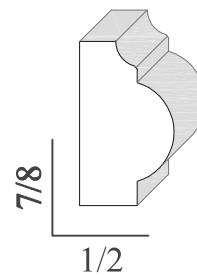

CTM | PA | 1075

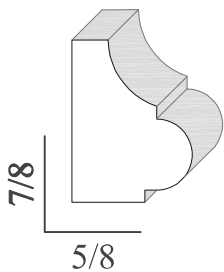

CTM | PA | 1076

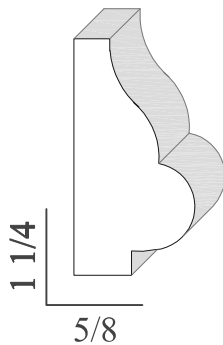

CTM | PA | 1077

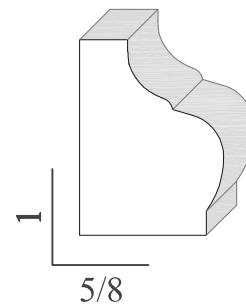

CTM | PA | 1078

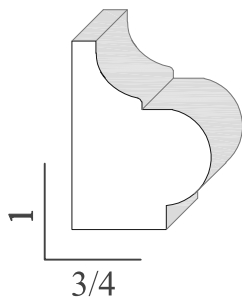

CTM | PA | 1079

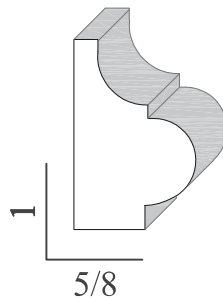

CTM | PA | 1080

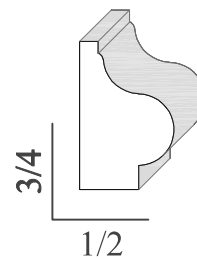

CTM | PA | 1081

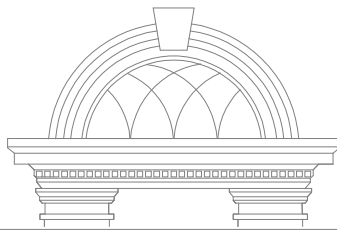

CT MOLDINGS

PANEL

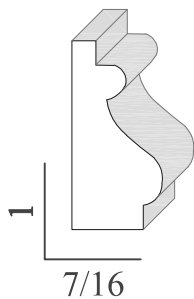

CTM | PA | 1082

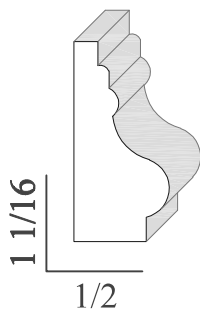

CTM | PA | 1083

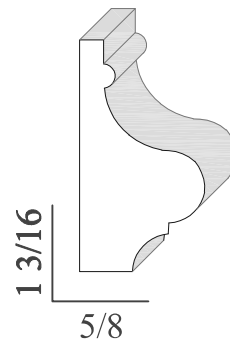

CTM | PA | 1084

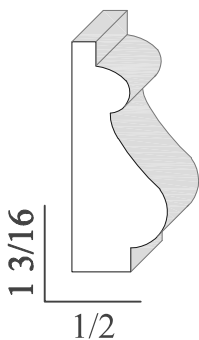

CTM | PA | 1085

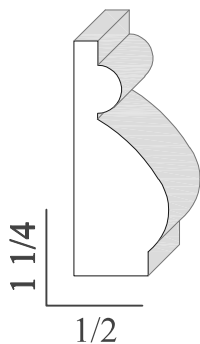

CTM | PA | 1086

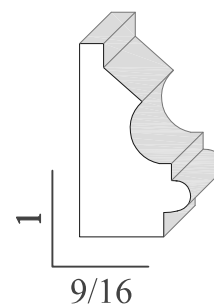

CTM | PA | 1087

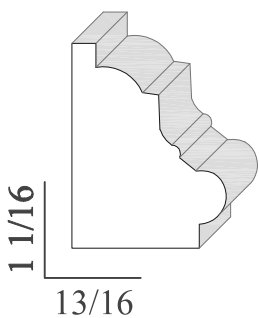

CTM | PA | 1088

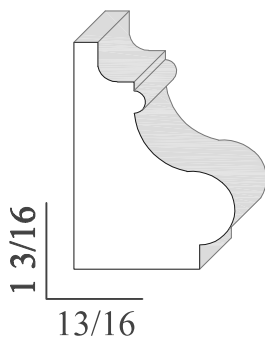

CTM | PA | 1089

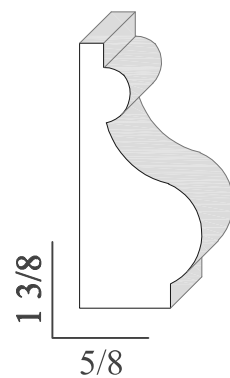

CTM | PA | 1090

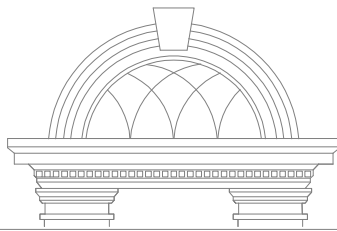

CT MOLDINGS

PANEL

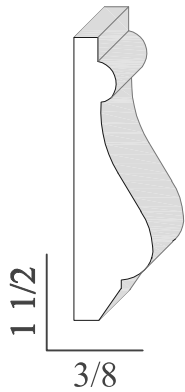

CTM | PA | 1091

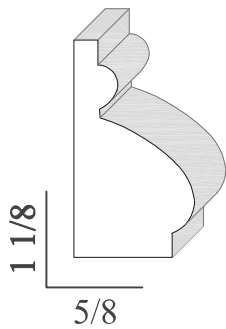

CTM | PA | 1092

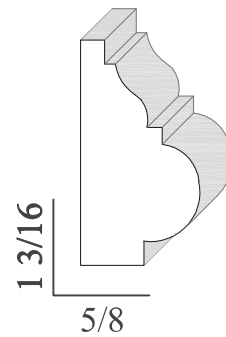

CTM | PA | 1093

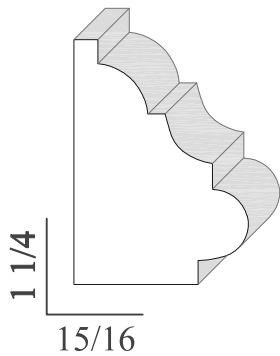

CTM | PA | 1094

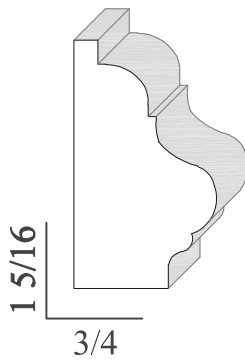

CTM | PA | 1095

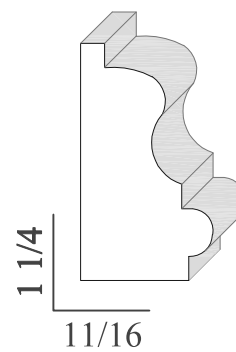

CTM | PA | 1096

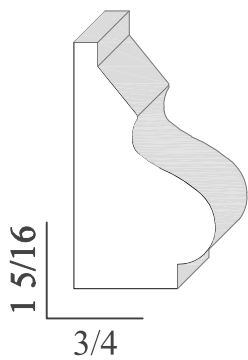

CTM | PA | 1097

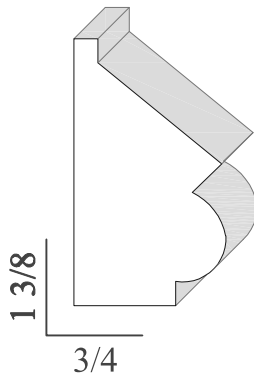

CTM | PA | 1098

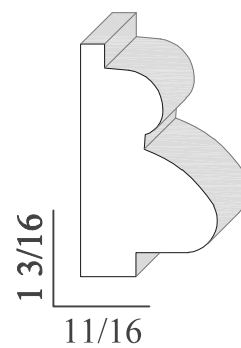

CTM | PA | 1099

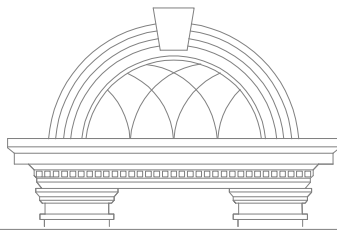

CT MOLDINGS

PANEL

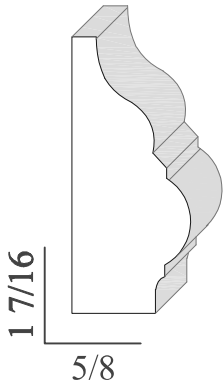

CTM | PA | 1100

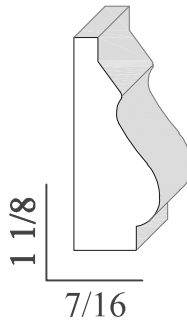

CTM | PA | 1101

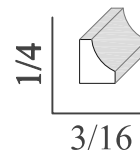

CTM | PA | 1102

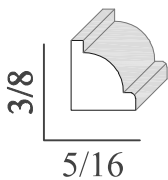

CTM | PA | 1103

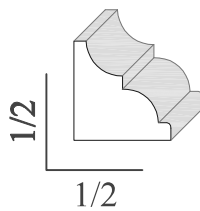

CTM | PA | 1104

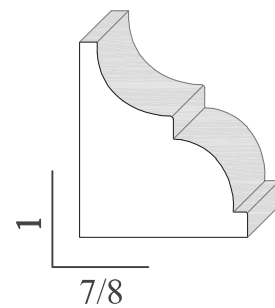

CTM | PA | 1104.1

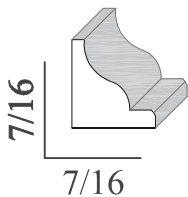

CTM | PA | 1105

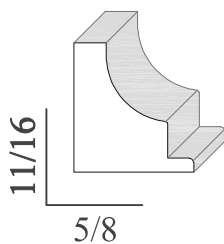

CTM | PA | 1105.1

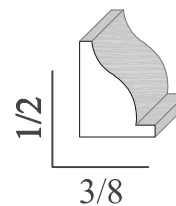

CTM | PA | 1106

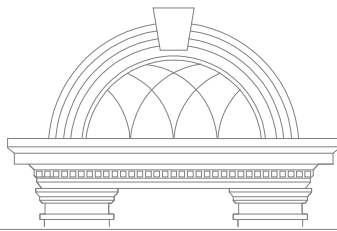

CT MOLDINGS

PANEL

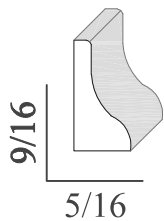

CTM | PA | 1107

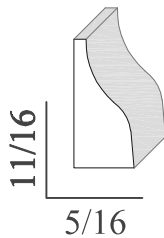

CTM | PA | 1108

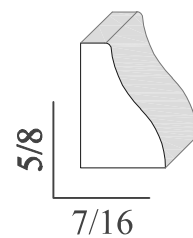

CTM | PA | 1109

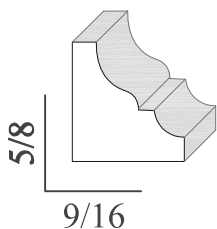

CTM | PA | 1110

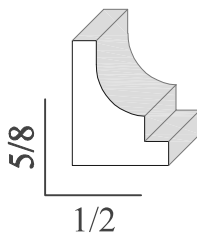

CTM | PA | 1111

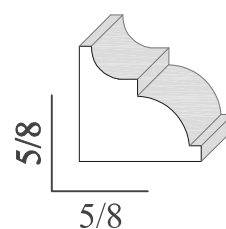

CTM | PA | 1112

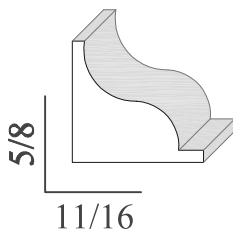

CTM | PA | 1113

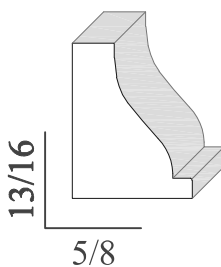

CTM | PA | 113.1

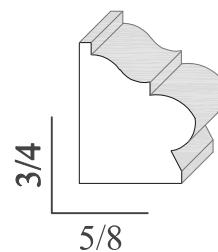

CTM | PA | 1114

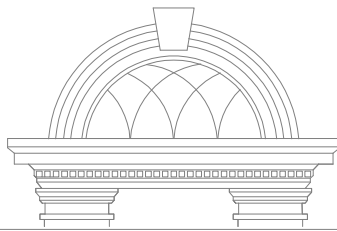

CT MOLDINGS

PANEL

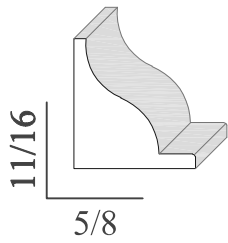

CTM | PA | 1115

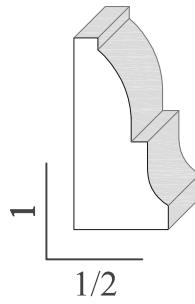

CTM | PA | 1116

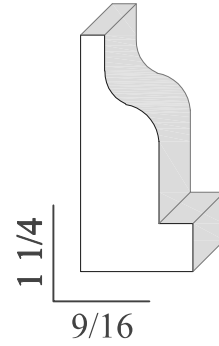

CTM | PA | 1117

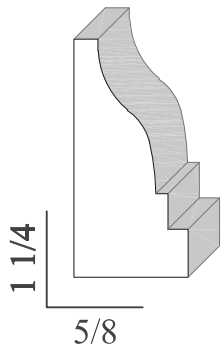

CTM | PA | 1118

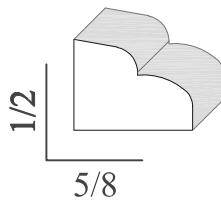

CTM | PA | 1119

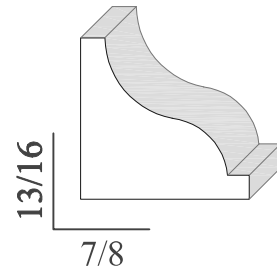

CTM | PA | 1120

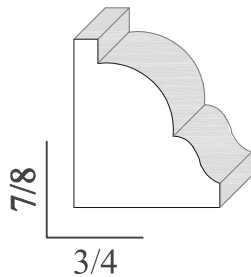

CTM | PA | 1121

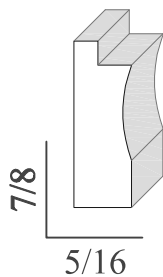

CTM | PA | 1122

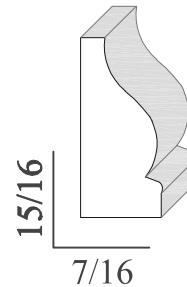

CTM | PA | 1123

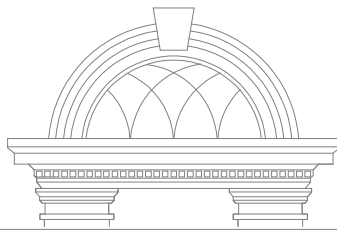

CT MOLDINGS

PANEL

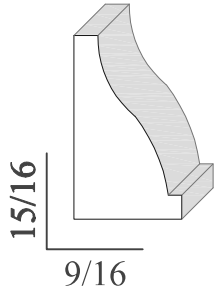

CTM | PA | 1124

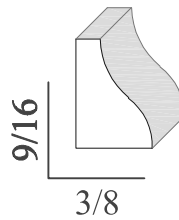

CTM | PA | 1125

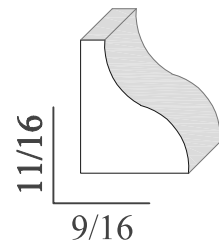

CTM | PA | 1126

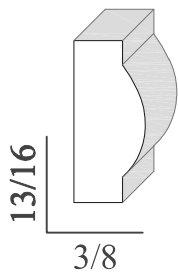

CTM | PA | 1127

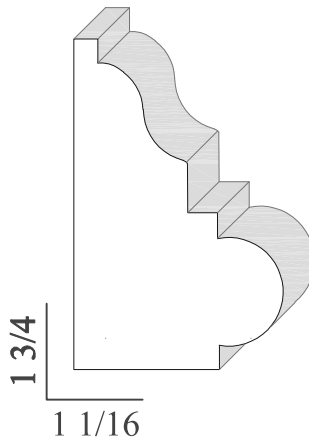

CTM | PA | 1128

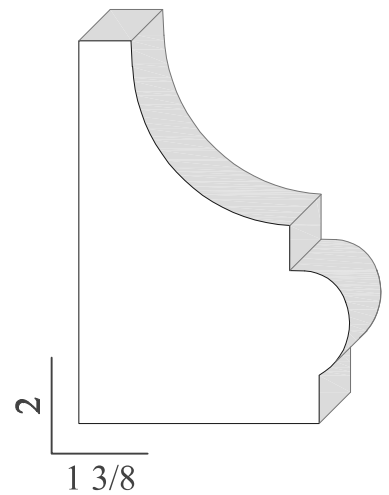

CTM | PA | 1129

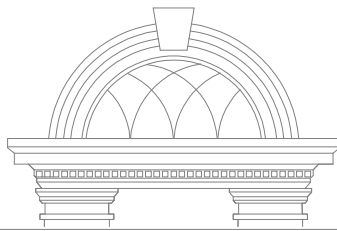

CT MOLDINGS

PANEL

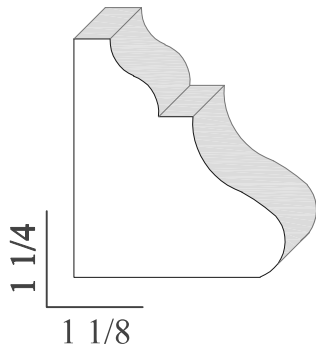

CTM | PA | 1130

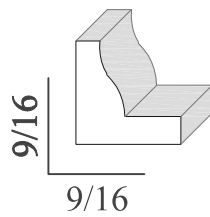

CTM | PA | 1131

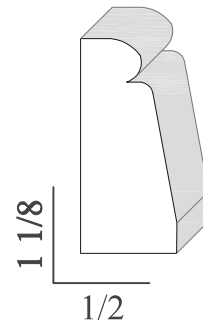

CTM | PA | 1132

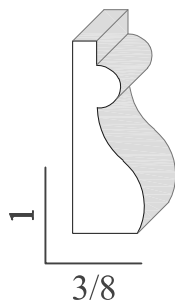

CTM | PA | 1133

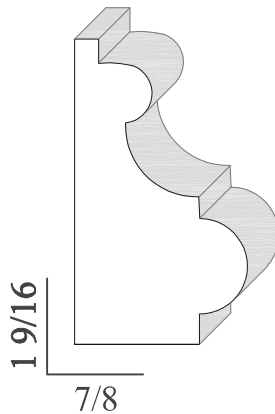

CTM | PA | 1134

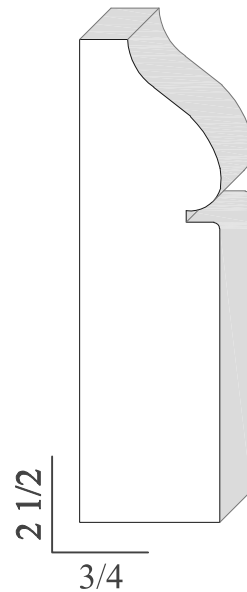

CTM | PA | 1135

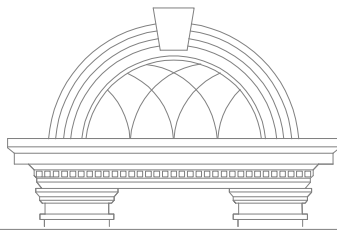

CT MOLDINGS

PANEL

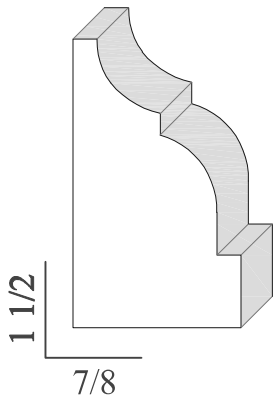

CTM | PA | 1136

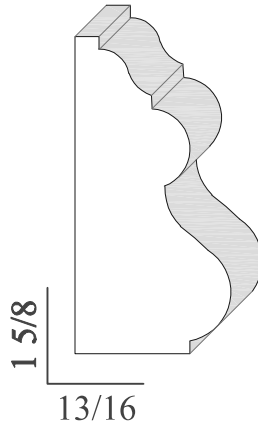

CTM | PA | 1137

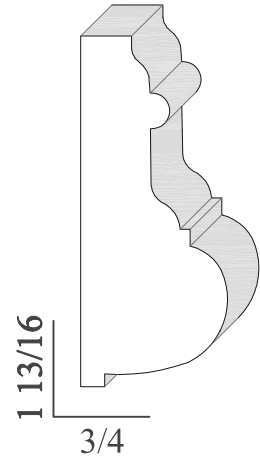

CTM | PA | 1138

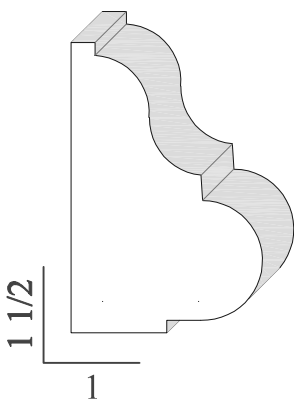

CTM | PA | 1139

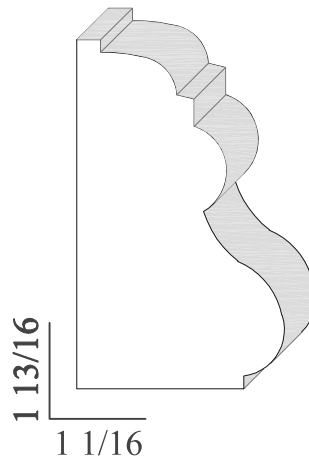

CTM | PA | 1140

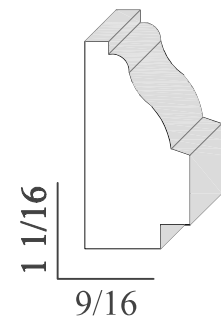

CTM | PA | 1141

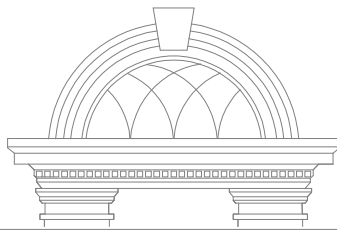

CT MOLDINGS

PANEL

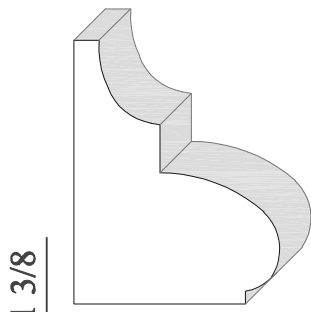

1 3/8
1 1/16

CTM | PA | 1142

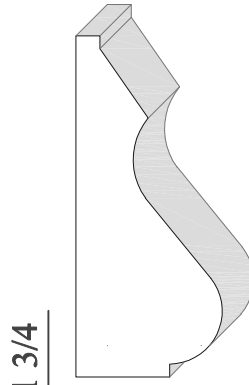

1 3/4
3/4

CTM | PA | 1143

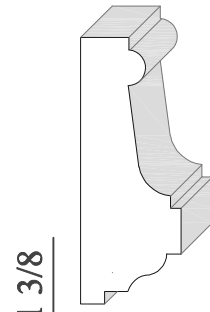

1 3/8
1/2

CTM | PA | 1144

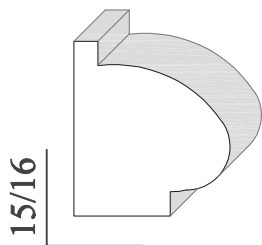

15/16
13/16

CTM | PA | 1145

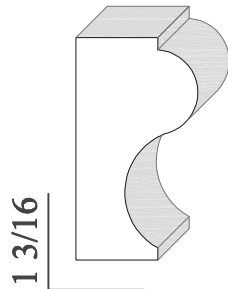

1 3/16
5/8

CTM | PA | 1146

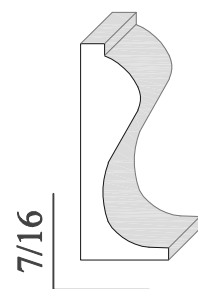

7/16
9/16

CTM | PA | 1147

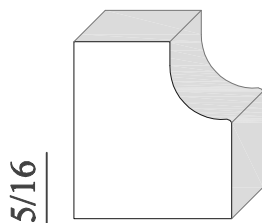

15/16
13/16

CTM | PA | 1148

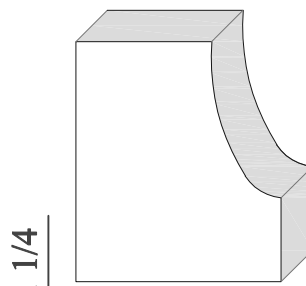

1 1/4
1 1/16

CTM | PA | 1149

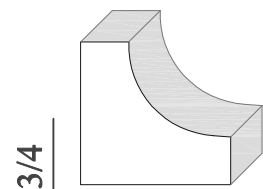

3/4
3/4

CTM | PA | 1150

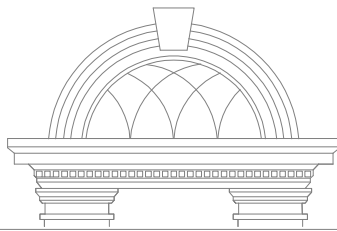

CT MOLDINGS

PANEL

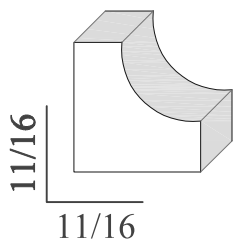

CTM | PA | 1151

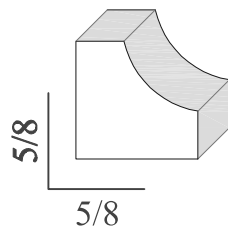

CTM | PA | 1152

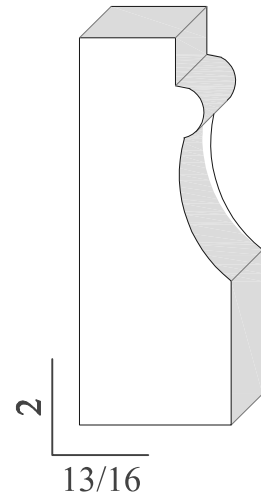

CTM | PA | 1153

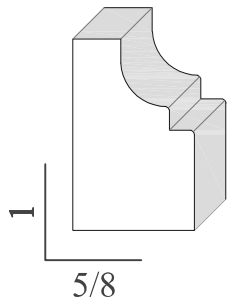

CTM | PA | 1154

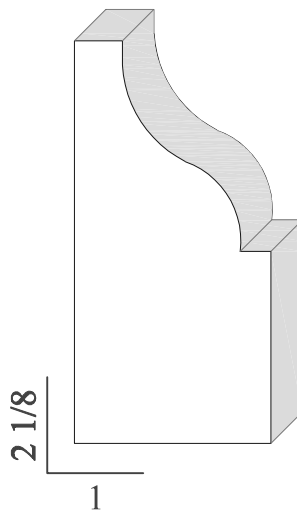

CTM | PA | 1155

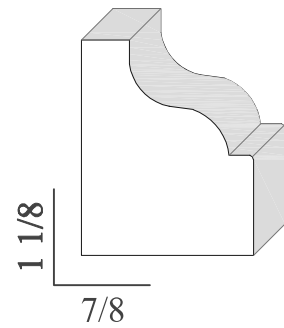

CTM | PA | 1156

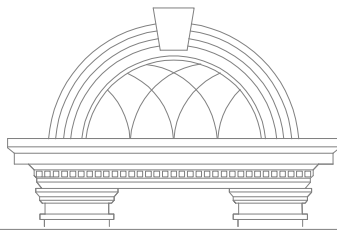

CT MOLDINGS

PANEL

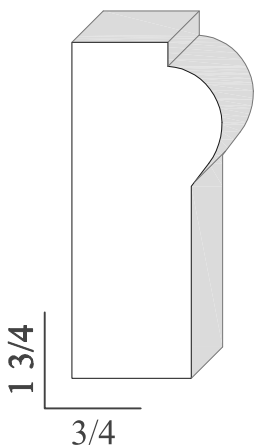

CTM | PA | 1157

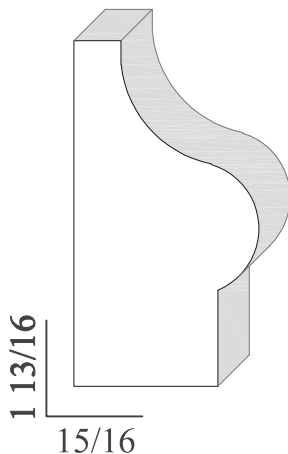

CTM | PA | 1158

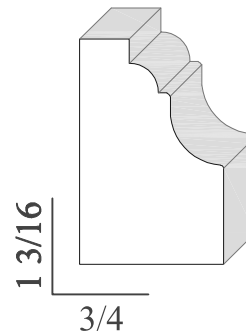

CTM | PA | 1159

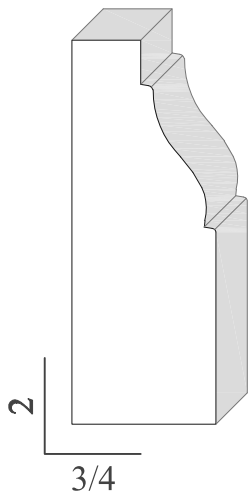

CTM | PA | 1160

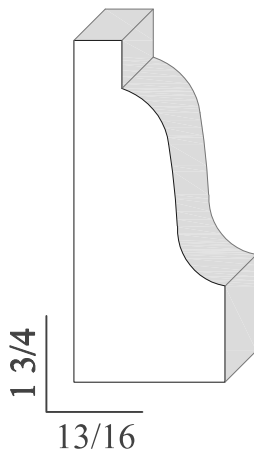

CTM | PA | 1161

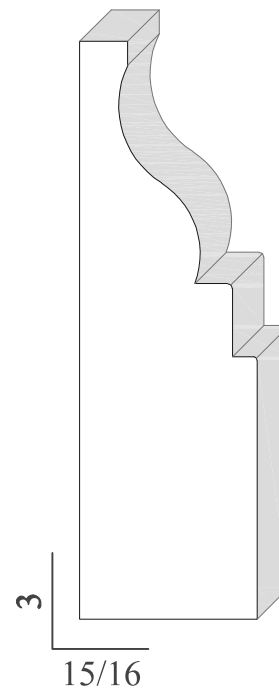

CTM | PA | 1162

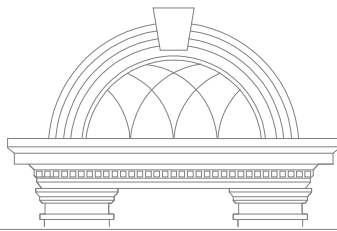

CT MOLDINGS

PANEL

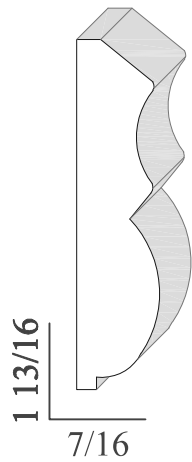

CTM | PA | 1163

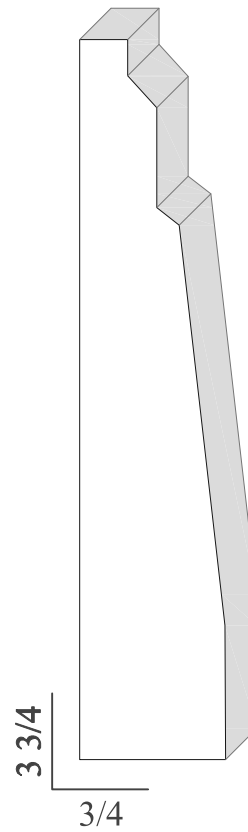

CTM | PA | 1164